

SOPORTES ANTI-VIBRATORIOS

1. Soportes para Máquinas.

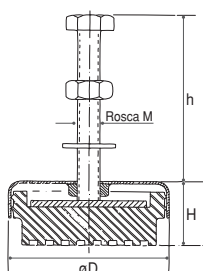
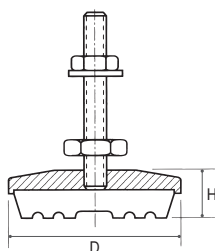
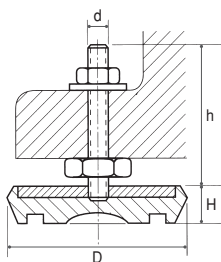
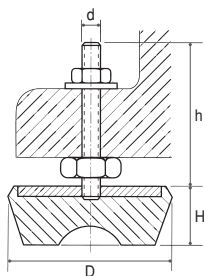

SOPORTES SERIE ALTA

Ref. catálogo	Modelo	Zona óptima trabajo (kg)	D (mm)	H (mm)	Ø Espiga	h (mm)
04130001	000	0 - 80	48	23	M - 8	40
04130002	00	50 - 120	60	25	M - 10	83
04130003	0	80 - 150	75	30	M - 12	90
04130004	1	120 - 300	90	33	M - 12	90
04130005	2	250 - 500	115	38	M - 16	110
04130006	3	400 - 800	125	45	M - 16	110
04130007	4	600 - 1.100	150	55	M - 16	110
04130008	5	1.000 - 1.600	170	57	M - 16	110
04130009	6	1.400 - 2.400	187	70	M - 20	115
04130010	7	2.000 - 3.500	210	75	M - 20	115

SOPORTES SERIE BAJA

Ref. catálogo	Modelo	Zona óptima trabajo (kg)	D (mm)	H (mm)	Ø Espiga	h (mm)
04130011	000B	0 - 60	40	15	M - 8	40
04130012	00B	30 - 100	63	18	M - 10	83
04130013	0B	80 - 150	70	22	M - 12	90
04130014	1B	100 - 350	90	25	M - 12	90
04130015	2B	300 - 600	106	29	M - 16	110
04130016	3B	500 - 900	127	33	M - 16	110
04130017	4B	800 - 1.500	150	39	M - 16	110
04130018	5B	1.300 - 2.000	170	42	M - 16	110

SOPORTES SERIE POLIURETANO. MODELO FIJO

Ref. catálogo	Modelo	Zona óptima trabajo (kg)	Material	D (mm)	H (mm)	Ø Espiga	h (mm)
04130019	F-60	200 - 800	Poliur.80	65	22	M - 12	90
04130020	F-90	500 - 2.000	Poliur.80	100	30	M - 16	110
04130021	F-120	2.000 - 4.000	Poliur.80	120	33	M - 20	120
04130022	F-160	4.000 - 6.000	Poliur.80	180	40	M - 20	115
04130023	F-200	5.000 - 10.000	Poliur.80	217	52	M - 24	145

SOPORTES SERIE CAM

Ref. catálogo	Modelo	Zona óptima trabajo (kg)	D (mm)	H (mm)	Ø Tornillo	h (mm)
04130024	CAM-50	0 - 100	50	24	M-8 x 50	40
04130025	CAM-75	100 - 350	76	35	M-10 x 75	65
04130026	CAM-85	350 - 600	90	40	M-12 x 90	80
04130027	CAM-90	600 - 900	90	49	M-16 x 120	115
04130028	CAM-125	1.000 - 2.500	125	52	M-16 x 120	110
04130029	CAM-170	2.500 - 4.000	170	57	M-20 x 130	120

2. Pies Niveladores.

BASE POLIAMIDA CON ESPIGAS ROTULA EN ACERO

Ref. catálogo	Código	Ø D (mm)	Rosca F	A (mm)	B (mm)	G (mm)	H (mm)	H1 (mm)	Carga kg max.
04130030	10224	40	M-8 x 75	27	75	16,5	102	105	1.000
04130031	10232	40	M-10 x 75	27	75	16,5	102	105	1.000
04130032	10242	50	M-10 x 75	30	75	20	105	108	1.100
04130033	10252	50	M-12 x 75	30	75	20	105	108	1.100
04130034	10272	65	M-14 x 100	36	100	23	136	139	1.500
04130035	10282	65	M-16 x 75	33	75	23	108	111	1.500
04130036	10284	65	M-16 x 100	33	100	23	133	136	1.500
04130037	10298	85	M-16 x 100	41	100	28	141	144	2.000
04130038	10302	85	M-16 x 150	41	150	28	191	194	2.000
04130039	10312	85	M-20 x 125	42	125	28	167	170	2.000
04130040	10328	105	M-16 x 125	50	125	33	175	178	3.000
04130041	10344	105	M-20 x 125	50	125	33	175	178	3.000
04130042	10398	125	M-20 x 150	55	150	38	205	208	4.000
04130043	10416	125	M-24 x 150	55	150	38	205	208	4.000

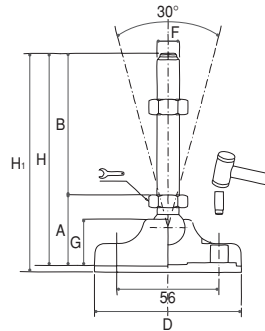

3. Amortiguadores.

AMORTIGUADORES ANTIVIBRATORIOS SERIE T

Ref. catálogo	Modelo	D (mm)	H (mm)	Métrica y Largo de espiga (L)	Flecha (mm)	Carga (kg)
04130044	10-10	10	10	M-4 x 10	2	10
04130045	10-15	10	15	M-4 x 10	3	8
04130046	12,5-10	13	10	M-5 x 12	2	12
04130047	12,5-15	13	15	M-5 x 12	3	10
04130048	12,5-20	13	20	M-5 x 12	3,5	8
04130049	16-8	16	8	M-4 x 10 ó M-5 x 12	1,5	15
04130050	16-10	16	10	M-4 x 10 ó M-5 x 12	1,5	20
04130051	16-15	16	15	M-4 x 10 ó M-5 x 12	3	20
04130052	16-20	16	20	M-4 x 10 ó M-5 x 12	4	20
04130053	20-10	20	10	M-6 x 13	2	30
04130054	20-15	20	15	M-6 x 13	3	25
04130055	20-20	20	20	M-6 x 18	4	25
04130056	20-25	20	25	M-6 x 18	5	25
04130057	20-30	20	30	M-6 x 18	7	25
04130058	25-10	25	10	M-8 x 20 ó M-6 x 16	2,5	50
04130059	25-15	25	15	M-8 x 20 ó M-6 x 16	3	50
04130060	25-20	25	20	M-8 x 20 ó M-6 x 16	4	50
04130061	25-22	25	22	M-8 x 20 ó M-6 x 16	4	45
04130062	25-25	25	25	M-8 x 20 ó M-6 x 16	5	40
04130063	25-30	25	30	M-8 x 20 ó M-6 x 16	6	35
04130064	30-10	30	10	M-8 x 20	2	90
04130065	30-15	30	15	M-8 x 20	3	90
04130066	30-20	30	20	M-8 x 20	4	90
04130067	30-25	30	25	M-8 x 20	5	85
04130068	30-30	30	30	M-8 x 20	6	80
04130069	30-40	30	40	M-8 x 20	8	60
04130070	35-35	35	35	M-8 x 20	8	90
04130071	40-20	40	20	M-10 x 25 ó M-8 x 20	4	160

Ref. catálogo	Modelo	D (mm)	H (mm)	Métrica y Largo de espiga (L)	Flecha (mm)	Carga (kg)
04130072	40-25	40	25	M-10 x 25 ó M-8 x 20	6	155
04130073	40-30	40	30	M-10 x 25 ó M-8 x 20	8	150
04130074	40-35	40	35	M-10 x 25 ó M-8 x 20	8	120
04130075	40-40	40	40	M-10 x 25 ó M-8 x 20	10	120
04130076	40-45	40	45	M-10 x 25 ó M-8 x 20	12	110
04130077	50-20	50	20	M-10 x 25	4	250
04130078	50-25	50	25	M-10 x 25	5,5	250
04130079	50-30	50	30	M-10 x 25	8	250
04130080	50-35	50	35	M-10 x 25	9	230
04130081	50-40	50	40	M-10 x 25	10	220
04130082	50-45	50	45	M-10 x 25	11	210
04130083	50-50	50	50	M-10 x 25	12	200
04130084	50-55	50	55	M-10 x 25	13	200
04130085	60-25	60	25	M-10 x 30	5	400
04130086	60-35	60	35	M-10 x 30	7	350
04130087	60-45	60	45	M-10 x 30	10	300
04130088	60-60	60	60	M-10 x 30	12	250
04130089	70-35	70	35	M-10 x 30	7	450
04130090	70-50	70	50	M-10 x 30	10	350
04130091	70-70	70	70	M-10 x 30	13	300
04130092	75-25	75	25	M-12 x 35	5	650
04130093	75-40	75	40	M-12 x 35	9	500
04130094	75-45	75	45	M-12 x 35	10	500
04130095	75-55	75	55	M-12 x 35	13	450
04130096	80-30	80	30	M-14 x 35	5,5	900
04130097	80-50	80	50	M-14 x 35	10	750
04130098	80-70	80	70	M-14 x 35	15	550
04130099	100-40	100	40	M-16 x 45	8	1.200
04130100	100-60	100	60	M-16 x 45	15	1.100
04130101	100-75	100	75	M-16 x 45	17	1.000
04130102	150-60	150	60	M-16 x 45	14	2.200
04130103	150-75	150	75	M-16 x 45	16	2.000

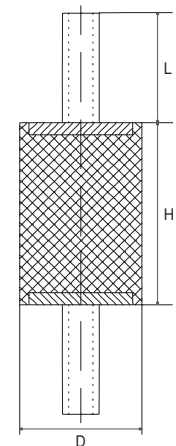

04/ UTILLAJE MÁQUINAS HERRAMIENTA

SOPORTES ANTI-VIBRATORIOS

AMORTIGUADORES ANTIVIBRATORIOS SERIE H

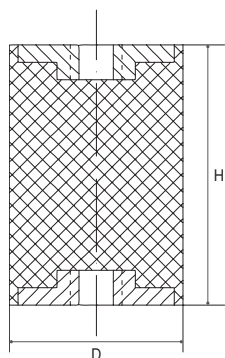

Ref. catálogo	Modelo	D (mm)	H (mm)	Rosca	Flecha (mm)	Carga (kg)
04130104	10-10	10	10	M-4	2	10
04130105	10-15	10	15	M-4	3	8
04130106	12,5-15	13	15	M-5	3	10
04130107	12,5-20	13	20	M-5	3,5	8
04130108	16-15	16	15	M-4 ó M-5	3	20
04130109	16-20	16	20	M-4 ó M-5	4	20
04130110	20-15	20	15	M-6	3	25
04130111	20-20	20	20	M-6	4	25
04130112	20-25	20	25	M-6	5	25
04130113	20-30	20	30	M-6	7	25
04130114	25-15	25	15	M-8 ó M-6	3	50
04130115	25-20	25	20	M-8 ó M-6	4	50
04130116	25-22	25	22	M-8 ó M-6	4	45
04130117	25-25	25	25	M-8 ó M-6	5	40
04130118	25-30	25	30	M-8 ó M-6	6	35
04130119	30-15	30	15	M-8	3	90
04130120	30-20	30	20	M-8	4	90
04130121	30-25	30	25	M-8	5	85
04130122	30-30	30	30	M-8	6	80
04130123	30-40	30	40	M-8	8	60
04130124	35-35	35	35	M-8	8	90
04130125	40-20	40	20	M-10 ó M-8	4	160
04130126	40-25	40	25	M-10 ó M-8	6	155
04130127	40-30	40	30	M-10 ó M-8	8	150
04130128	40-35	40	35	M-10 ó M-8	8	120
04130129	40-40	40	40	M-10 ó M-8	10	120
04130130	40-45	40	45	M-10 ó M-8	12	110
04130131	50-20	50	20	M-10	4	250

Ref. catálogo	Modelo	D (mm)	H (mm)	Rosca	Flecha (mm)	Carga (kg)
04130132	50-25	50	25	M-10	5,5	250
04130133	50-30	50	30	M-10	8	250
04130134	50-35	50	35	M-10	9	230
04130135	50-40	50	40	M-10	10	220
04130136	50-45	50	45	M-10	11	210
04130137	50-50	50	50	M-10	12	200
04130138	50-55	50	55	M-10	13	200
04130139	60-25	60	25	M-10	5	400
04130140	60-35	60	35	M-10	7	350
04130141	60-45	60	45	M-10	10	300
04130142	60-60	60	60	M-10	12	250
04130143	70-35	70	35	M-10	7	450
04130144	70-50	70	50	M-10	10	350
04130145	70-70	70	70	M-10	13	300
04130146	75-25	75	25	M-12	5	650
04130147	75-40	75	40	M-12	9	500
04130148	75-45	75	45	M-12	10	500
04130149	75-55	75	55	M-12	13	450
04130150	80-30	80	30	M-14	5,5	900
04130151	80-50	80	50	M-14	10	750
04130152	80-70	80	70	M-14	15	550
04130153	100-40	100	40	M-16	8	1.200
04130154	100-60	100	60	M-16	15	1.100
04130155	100-75	100	75	M-16	17	1.000
04130156	150-60	150	60	M-16	14	2.200
04130157	150-75	150	75	M-16	16	2.000

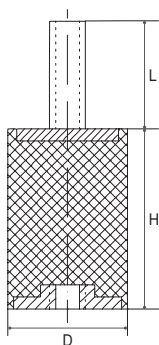

AMORTIGUADORES ANTIVIBRATORIOS SERIE TH

Ref. catálogo	Modelo	D (mm)	H (mm)	Métrica y Largo de espiga (L)	Flecha (mm)	Carga (kg)
04130158	10-10	10	10	M-4 x 10	2	10
04130159	10-15	10	15	M-4 x 10	3	8
04130160	12,5-10	13	10	M-5 x 12	2	12
04130161	12,5-15	13	15	M-5 x 12	3	10
04130162	12,5-20	13	20	M-5 x 12	3,5	8
04130163	16-8	16	8	M-4 x 10 ó M-5 x 12	1,5	15
04130164	16-10	16	10	M-4 x 10 ó M-5 x 12	1,5	20
04130165	16-15	16	15	M-4 x 10 ó M-5 x 12	3	20
04130166	16-20	16	20	M-4 x 10 ó M-5 x 12	4	20
04130167	20-10	20	10	M-6 x 13	2	30
04130168	20-15	20	15	M-6 x 13	3	25
04130169	20-20	20	20	M-6 x 18	4	25
04130170	20-25	20	25	M-6 x 18	5	25
04130171	20-30	20	30	M-6 x 18	7	25
04130172	25-10	25	10	M-8 x 20 ó M-6 x 16	2,5	50
04130173	25-15	25	15	M-8 x 20 ó M-6 x 16	3	50
04130174	25-20	25	20	M-8 x 20 ó M-6 x 16	4	50
04130175	25-22	25	22	M-8 x 20 ó M-6 x 16	4	45

Ref. catálogo	Modelo	D (mm)	H (mm)	Métrica y Largo de espiga (L)	Flecha (mm)	Carga (kg)
04130176	25-25	25	25	M-8 x 20 ó M-6 x 16	5	40
04130177	25-30	25	30	M-8 x 20 ó M-6 x 16	6	35
04130178	30-15	30	15	M-8 x 20	3	90
04130179	30-20	30	20	M-8 x 20	4	90
04130180	30-25	30	25	M-8 x 20	5	85
04130181	30-30	30	30	M-8 x 20	6	80
04130182	30-40	30	40	M-8 x 20	8	60
04130183	35-35	35	35	M-8 x 20	8	90
04130184	40-20	40	20	M-10 x 25 ó M-8 x 20	4	160
04130185	40-25	40	25	M-10 x 25 ó M-8 x 20	6	155
04130186	40-30	40	30	M-10 x 25 ó M-8 x 20	8	150
04130187	40-35	40	35	M-10 x 25 ó M-8 x 20	8	120
04130188	40-40	40	40	M-10 x 25 ó M-8 x 20	10	120
04130189	40-45	40	45	M-10 x 25 ó M-8 x 20	12	110
04130190	50-20	50	20	M-10 x 25	4	250
04130191	50-25	50	25	M-10 x 25	5,5	250
04130192	50-30	50	30	M-10 x 25	8	250
04130193	50-35	50	35	M-10 x 25	9	230

Ref. catálogo	Modelo	D (mm)	H (mm)	Métrica y Largo de espiga (L)	Flecha (mm)	Carga (kg)
04130194	50-40	50	40	M-10 x 25	10	220
04130195	50-45	50	45	M-10 x 25	11	210
04130196	50-50	50	50	M-10 x 25	12	200
04130197	50-55	50	55	M-10 x 25	13	200
04130198	60-25	60	25	M-10 x 30	5	400
04130199	60-35	60	35	M-10 x 30	7	350
04130200	60-45	60	45	M-10 x 30	10	300
04130201	60-60	60	60	M-10 x 30	12	250
04130202	70-35	70	35	M-10 x 30	7	450
04130203	70-50	70	50	M-10 x 30	10	350
04130204	70-70	70	70	M-10 x 30	13	300
04130205	75-25	75	25	M-12 x 35	5	650

Ref. catálogo	Modelo	D (mm)	H (mm)	Métrica y Largo de espiga (L)	Flecha (mm)	Carga (kg)
04130206	75-40	75	40	M-12 x 35	9	500
04130207	75-45	75	45	M-12 x 35	10	500
04130208	75-55	75	55	M-12 x 35	13	450
04130209	80-30	80	30	M-14 x 35	5,5	900
04130210	80-50	80	50	M-14 x 35	10	750
04130211	80-70	80	70	M-14 x 35	15	550
04130212	100-40	100	40	M-16 x 45	8	1.200
04130213	100-60	100	60	M-16 x 45	15	1.100
04130214	100-75	100	75	M-16 x 45	17	1.000
04130215	150-60	150	60	M-16 x 45	14	2.200
04130216	150-75	150	75	M-16 x 45	16	2.000

AMORTIGUADORES ANTIVIBRATORIOS SERIE TS

Ref. catálogo	Modelo	D (mm)	H (mm)	Métrica y Largo de espiga (L)	Flecha (mm)	Carga (kg)
04130217	10-10	10	10	M-4 x 10	2	10
04130218	10-15	10	15	M-4 x 10	3	8
04130219	12,5-10	13	10	M-5 x 12	2	12
04130220	12,5-15	13	15	M-5 x 12	3	10
04130221	12,5-20	13	20	M-5 x 12	3,5	8
04130222	16-8	16	8	M-4 x 10 ó M-5 x 12	1,5	15
04130223	16-10	16	10	M-4 x 10 ó M-5 x 12	1,5	20
04130224	16-15	16	15	M-4 x 10 ó M-5 x 12	3	20
04130225	16-20	16	20	M-4 x 10 ó M-5 x 12	4	20
04130226	20-10	20	10	M-6 x 13	2	30
04130227	20-15	20	15	M-6 x 13	3	25
04130228	20-20	20	20	M-6 x 18	4	25
04130229	20-25	20	25	M-6 x 18	5	25
04130230	20-30	20	30	M-6 x 18	7	25
04130231	25-10	25	10	M-8 x 20 ó M-6 x 16	2,5	50
04130232	25-15	25	15	M-8 x 20 ó M-6 x 16	3	50
04130233	25-20	25	20	M-8 x 20 ó M-6 x 16	4	50
04130234	25-22	25	22	M-8 x 20 ó M-6 x 16	4	45
04130235	25-25	25	25	M-8 x 20 ó M-6 x 16	5	40
04130236	25-30	25	30	M-8 x 20 ó M-6 x 16	6	35
04130237	30-10	30	10	M-8 x 20	2	90
04130238	30-15	30	15	M-8 x 20	3	90
04130239	30-20	30	20	M-8 x 20	4	90
04130240	30-25	30	25	M-8 x 20	5	85
04130241	30-30	30	30	M-8 x 20	6	80
04130242	30-40	30	40	M-8 x 20	8	60
04130243	35-35	35	35	M-8 x 20	8	90
04130244	40-20	40	20	M-10 x 25 ó M-8 x 20	4	160
04130245	40-25	40	25	M-10 x 25 ó M-8 x 20	6	155
04130246	40-30	40	30	M-10 x 25 ó M-8 x 20	8	150

Ref. catálogo	Modelo	D (mm)	H (mm)	Métrica y Largo de espiga (L)	Flecha (mm)	Carga (kg)
04130247	40-35	40	35	M-10 x 25 ó M-8 x 20	8	120
04130248	40-40	40	40	M-10 x 25 ó M-8 x 20	10	120
04130249	40-45	40	45	M-10 x 25 ó M-8 x 20	12	110
04130250	50-20	50	20	M-10 x 25	4	250
04130251	50-25	50	25	M-10 x 25	5,5	250
04130252	50-30	50	30	M-10 x 25	8	250
04130253	50-35	50	35	M-10 x 25	9	230
04130254	50-40	50	40	M-10 x 25	10	220
04130255	50-45	50	45	M-10 x 25	11	210
04130256	50-50	50	50	M-10 x 25	12	200
04130257	50-55	50	55	M-10 x 25	13	200
04130258	60-25	60	25	M-10 x 30	5	400
04130259	60-35	60	35	M-10 x 30	7	350
04130260	60-45	60	45	M-10 x 30	10	300
04130261	60-60	60	60	M-10 x 30	12	250
04130262	70-35	70	35	M-10 x 30	7	450
04130263	70-50	70	50	M-10 x 30	10	350
04130264	70-70	70	70	M-10 x 30	13	300
04130265	75-25	75	25	M-12 x 35	5	650
04130266	75-40	75	40	M-12 x 35	9	500
04130267	75-45	75	45	M-12 x 35	10	500
04130268	75-55	75	55	M-12 x 35	13	450
04130269	80-30	80	30	M-14 x 35	5,5	900
04130270	80-50	80	50	M-14 x 35	10	750
04130271	80-70	80	70	M-14 x 35	15	550
04130272	100-40	100	40	M-16 x 45	8	1.200
04130273	100-60	100	60	M-16 x 45	15	1.100
04130274	100-75	100	75	M-16 x 45	17	1.000
04130275	150-60	150	60	M-16 x 45	14	2.200
04130276	150-75	150	75	M-16 x 45	16	2.000

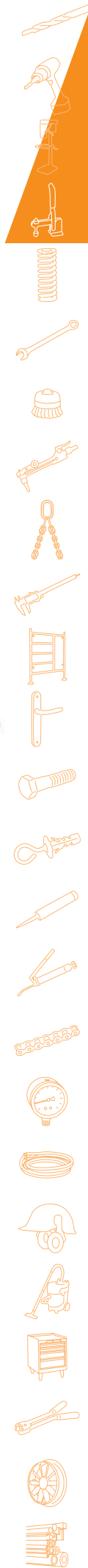
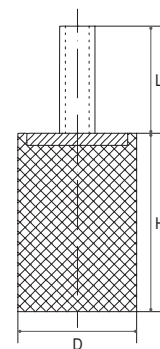

04/ UTILLAJE MÁQUINAS HERRAMIENTA

SOPORTES ANTI-VIBRATORIOS / PROTECCIONES PARA MÁQUINAS

AMORTIGUADORES DIÁBOLO

SERIE TD

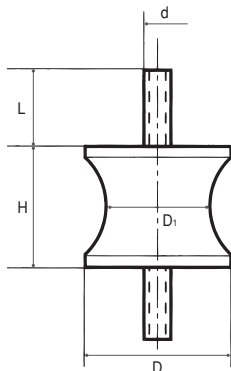

Ref. catálogo	Modelo	D (mm)	H (mm)	D1 (mm)	Rosca (d)	L (mm)	Flecha (mm)	Carga (kg)
04130277	TD 20-20	20	20	12	M-6	18	2,5	15
04130278	TD 30-25	30	25	24	M-8	20	4	40
04130279	TD 40-28	40	28	22	M-10	25	5	60
04130280	TD 57-44	57	44	25	M-8	20	5	40
04130281	TD 60-36	60	36	37	M-10	30	5	90
04130282	TD 60-43	60	43	35	M-10	30	4	70
04130283	TD 60-60	60	60	51	M-10	30	6	150
04130284	TD 70-56	70	56	50	M-12	35	6	220
04130285	TD 80-65	80	63	70	M-14	35	8	400
04130286	TD 90-77	90	77	79	M-16	45	7	500
04130287	TD 108-85	108	85	95	M-16	45	10	800
04130288	TD 130-96	130	96	115	M-16	45	13	1.400

SERIE HD

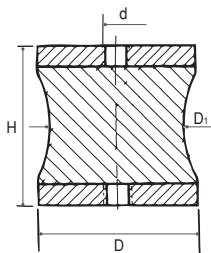

Ref. catálogo	Modelo	D (mm)	H (mm)	D1 (mm)	Rosca (d)	Flecha (mm)	Carga (kg)
04130289	HD 20-20	20	20	12	M-6	2,5	15
04130290	HD 30-25	30	25	24	M-8	4	40
04130291	HD 40-28	40	28	22	M-10	5	60
04130292	HD 60-36	60	36	37	M-10	5	90
04130293	HD 60-43	60	43	35	M-10	4	70
04130294	HD 60-60	60	60	51	M-10	6	150
04130295	HD 70-56	70	56	50	M-12	6	220
04130296	HD 80-65	80	65	70	M-12	8	400
04130297	HD 90-50	90	50	80	M-12	4	800
04130298	HD 90-77	90	77	79	M-12	7	500
04130299	HD 108-85	108	85	95	M-16	10	800
04130300	HD 130-96	130	96	115	M-16	13	1.400

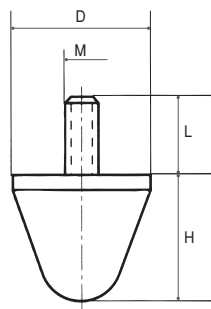

TOPES PROGRESIVOS MACHO

Ref. catálogo	Modelo	D (mm)	H (mm)	Rosca (M)	L (mm)	Carga (kg)
04130301	TP-20	20	20	M-6	18	70
04130302	TP-25	25	20	M-8	20	100
04130303	TP-30	30	30	M-6	17	150
04130304	TP-30	30	30	M-8	20	150
04130305	TP-50	50	48	M-10	25	380
04130306	TP-50x64	50	64	M-8	35	370
04130307	TP-70	70	60	M-12	35	550
04130308	TP-90	90	74	M-16	45	1.100
04130309	TP-95	95	82	M-16	45	1.100

4. Amortiguadores Metálicos.

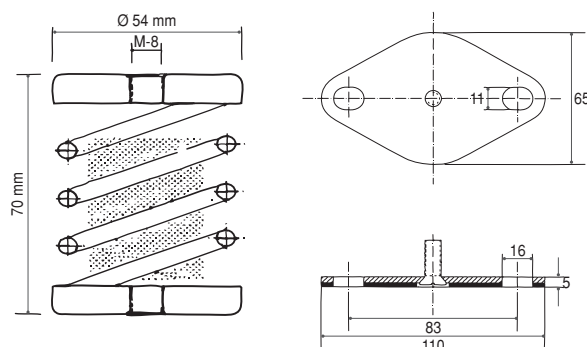

Ref. catálogo	Modelo	Carga (kg)
04130310	M-25	10-25
04130311	M-50	25-50
04130312	M-75	50-75
04130313	M-100	75-100

OPCIONAL:
En todos los casos puede adaptarse una base antideslizante.