





LANZAS FLEXIBLES PARA TALADRINA

Lanzas Loc-Line

MODELO 1/4" - 6 mm

	Ref. catálogo	Código	Incluye
	04100001	40.413	20 rótulas articuladas
			3 bocas de salida: 1,60 - 3,17 - 6,35 mm
			2 racord: 1/4 - 1/8 largo total: 330 mm
	04100002	41.401	20 rótulas articuladas 300 mm
	04100003	41.407	Boca de salida plana 24 x 0,8 (2 uds.)
	04100004	21.192	Grifo macho 1/4 NPT (2 uds.)
	04100005	21.193	Grifo hembra 1/4 NPT (2 uds.)
	04100006	21.194	Grifo en línea (2 uds.)
	04100007	41.405	Racord de 1/8 NPT (4 uds.)
	04100008	41.406	Racord de 1/4 NPT (4 uds.)
	04100009	41.402	Boca de salida Ø 1,60 (4 uds.)
	04100010	41.403	Boca de salida Ø 3,17 (4 uds.)
	04100011	41.404	Boca de salida Ø 6,35 (4 uds.)
	04100012	78.001	Pinza de montaje de 1/4

MODELO 1/2" - 12 mm

	Ref. catálogo	Código	Incluye
	04100013	50.813	12 rótulas articuladas
			3 bocas de salida: 9,30 - 12,70 - 6,35 mm
			2 racord: 3/8 y 1/2 largo total: 330 mm
	04100014	51.801	12 rótulas largo 270 mm
	04100015	51.806	Boca de salida Ø 6,35 (4 uds.)
	04100016	51.802	Boca de salida Ø 9,30 (4 uds.)
	04100017	51.803	Boca de salida Ø 12,70 (4 uds.)
	04100018	51.807	Boca plana 32 x 4,50 (2 uds.)
	04100019	51.804	Racord 1/2 NPT (4 uds.)
	04100020	51.805	Racord 1/2 NPT (4 uds.)
	04100021	32.092	Grifo macho de 1/2 NPT (2 uds.)
	04100022	32.093	Grifo hembra de 1/2 NPT (2 uds.)
	04100023	32.094	Grifo en línea (2 uds.)
	04100024	78.002	Pinza de montaje de 1/2

POMOS Y TIRADORES

1. Esfera Lisa.

Con Inserto Metálico

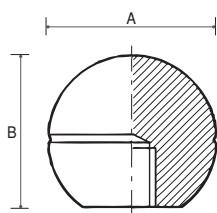

DUROPLASTO ACABADO BRILLANTE

Ref. catálogo	Código	Medida	A	B
04110001	R351-6	M6	25	23
04110002	R351-8	M8	25	23
04110003	R352-6	M6	32	30
04110004	R352-8	M8	32	30
04110005	R352-10	M10	32	30
04110006	R353-8	M8	38	36

Ref. catálogo	Código	Medida	A	B
04110007	R353-10	M10	38	36
04110008	R354-10	M10	44	43
04110009	R354-12	M12	44	43
04110010	R355-12	M12	51	49
04110011	R355-16	M16	51	49

2. Manilla Giratoria Macho.

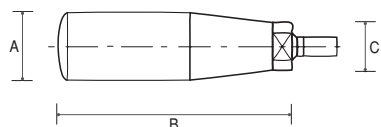

TERMOPLÁSTICO ACABADO MATE

Ref. catálogo	Código	Medida	A	B	C
04110025	R3155M-6-12	M6x12	20	55	12
04110026	R3167M-8-15	M8x15	23	67	18
04110027	R3177M-8-15	M8x15	25	77	18
04110028	R3177M-10-15	M10x15	25	77	18
04110029	R3187M-10-15	M10x15	27	87	20
04110030	R3187M-12-15	M12x15	27	87	20
04110031	R3197M-10-15	M10x15	29	97	20
04110032	R3197M-12-15	M12x15	29	97	20

3. Asa Punte.

Pasante

TERMOPLÁSTICO REFORZADO ACABADO MATE

Ref. catálogo	Código	Ø	A	B	C	D	E
04110012	R2093-6	6,5	119,5	35	93,4	29	26
04110013	R2117-8	8,5	145	40	117	34	29
04110014	R2132-8	8,5	163	45	132	38	31
04110015	R2179-8	8,5	213	50	179	42,5	35

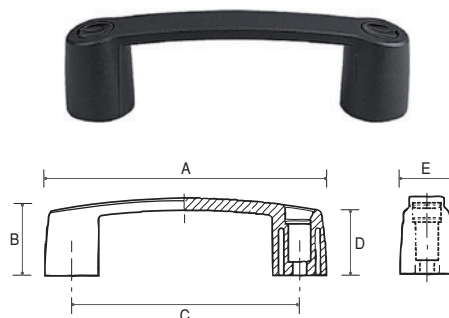

Con Inserto Roscado

TERMOPLÁSTICO REFORZADO ACABADO MATE

Ref. catálogo	Código	Medida	A	B	C	D	E
04110016	R2093F-6	M6	119,5	35	93,4	29	26
04110017	R2093F-8	M8	119,5	35	93,4	29	26
04110018	R2117F-6	M6	145	40	117	34	29
04110019	R2117F-8	M8	145	40	117	34	29
04110020	R2132F-6	M6	163	45	132	38	31
04110021	R2132F-8	M8	163	45	132	38	31
04110022	R2179F-8	M8	213	50	179	42,5	35
04110023	R2179F-10	M10	213	50	179	42,5	35
04110024	R2179F-12	M12	213	50	179	42,5	35

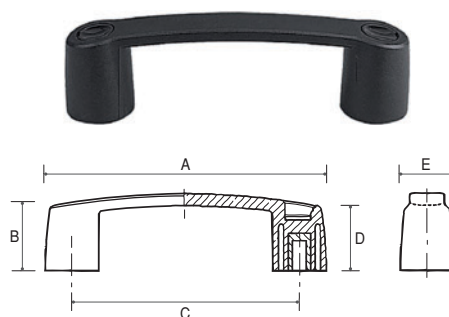

4. Volante 2 Radios.

Con Manilla Escamoteable

TERMOPLÁSTICO REFORZADO ACABADO MATE

Ref. catálogo	Código	A	B	C	D	E	F	Ø Ag. guía	Ø Ag. máx
04110033	R90-130	130	53	31	35	23	60	5	16
04110034	R90-160	160	59	40	40	26	70	5	20

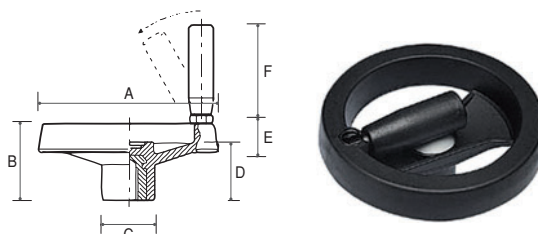

5. Mando Cuatro Puntas.

Hembra

DUROPLASTO ACABADO BRILLANTE

Ref. catálogo	Código	Medida	A	B	C	D	E
04110035	R1260-6	M6	38	12	18	8	20
04110036	R1260-8	M8	38	12	18	8	20
04110037	R1261-8	M8	50	13	21	12	25
04110038	R1261-10	M10	50	13	21	12	25
04110039	R1262-8	M8	60	14	24	14	28
04110040	R1262-10	M10	60	14	24	14	28
04110041	R1263-10	M10	80	17	29	17	34
04110042	R1263-12	M12	80	17	29	17	34
04110043	R1264-10	M10	100	20	33	18	38
04110044	R1264-12	M12	100	20	33	18	38
04110045	R1264-16	M16	100	20	33	18	38

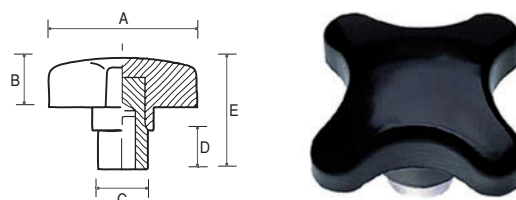

04/ UTILLAJE MÁQUINAS HERRAMIENTA

POMOS Y TIRADORES / MOLETEADORES

Macho

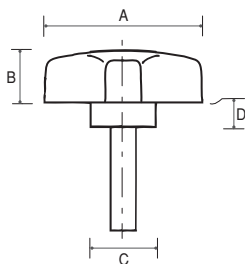

DUROPLASTO ACABADO BRILLANTE

Ref. catálogo	Código	Medida	A	B	C	D
04110046	R1260M-6-20	M6x20	38	12	13	8
04110047	R1260M-6-25	M6x25	38	12	13	8
04110048	R1261M-8-25	M8x25	50	13	15	12
04110049	R1261M-8-30	M8x30	50	13	15	12
04110050	R1262M-10-30	M10x30	60	14	18	14
04110051	R1262M-10-40	M10x40	60	14	18	14
04110052	R1263M-12-40	M12x40	80	17	22	16
04110053	R1263M-12-50	M12x50	80	17	22	16

6. Empuñadura Graduable.

Hembra

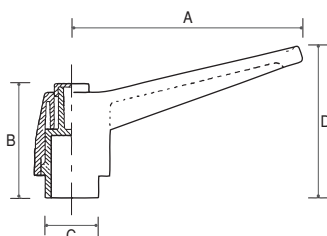

TERMOPLÁSTICO REFORZADO

Ref. catálogo	Código	Medida	A	B	C	D
04110054	R2843-5	M5	43	26	12	32
04110055	R2843-6	M6	43	26	12	32
04110056	R2865-6	M6	65	37	15	46
04110057	R2865-8	M8	65	37	15	46
04110058	R2883-8	M8	83	46	19	57
04110059	R2883-10	M10	83	46	19	57
04110060	R28104-10	M10	104	51	24	68
04110061	R28104-12	M12	104	51	24	68
04110062	R28104-16	M16	104	51	24	68

Macho

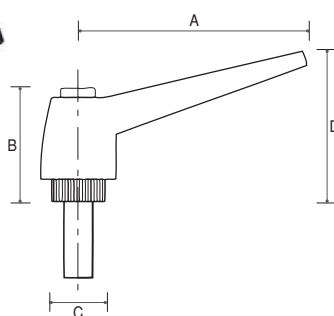

TERMOPLÁSTICO REFORZADO

Ref. catálogo	Código	Medida	A	B	C	D
04110063	R2843M-5-15	M5x15	43	26	12	32
04110064	R2843M-5-20	M5x20	43	26	12	32
04110065	R2843M-5-25	M5x25	43	26	12	32
04110066	R2843M-6-15	M6x15	43	26	12	32
04110067	R2843M-6-20	M6x20	43	26	12	32
04110068	R2843M-6-25	M6x25	43	26	12	32
04110069	R2865M-8-20	M8x20	65	37	15	46
04110070	R2865M-8-30	M8x30	65	37	15	46
04110071	R2865M-8-40	M8x40	65	37	15	46
04110072	R2865M-8-50	M8x50	65	37	15	46
04110073	R2883M-10-30	M10x30	83	46	19	57
04110074	R2883M-10-40	M10x40	83	46	19	57
04110075	R2883M-10-50	M10x50	83	46	19	57
04110076	R28104M-12-30	M12x30	104	51	24	68
04110077	R28104M-12-35	M12x35	104	51	24	68
04110078	R28104M-12-50	M12x50	104	51	24	68
04110079	R28104M-16-35	M16x35	104	51	24	68
04110080	R28104M-16-50	M16x50	104	51	24	68

MOLETEADORES

1. Moleteador Simple por Presión.

M1



Herramienta aplicable en todo tipo de moleteados / Recomendada para realizar moleteados rectos tipo RAA y para máquinas de tornos convencionales y otros / Para montar moletas tipo: AA / BR 30° / BR 45° / BL 30° / BL 45° / GE 30° / GE 45° / GV 30° / GV 45°.

Ref. catálogo	Código	Capacidad	Moleta	Largo x Ancho x Alto	Peso (kg)
04120001	M1 20.08.14	Ø 8-200	20 x 8 x 6	112 x 14 x 14	0,185